

Universal racking

Extensible

Basic Kit

Sliding

Carrier

Make a good van even better.

Now you have bought your van, it may be the most important part of your business for years to come. But it's just a shell and you must consider your options for turning it into an effective work tool.

Consider efficiency and safety when loading your van with tools and equipment. Know exactly where things are and know that they will stay in place when you are on the move.

Here at System Edström we've used over 50 years experience to design and manufacture universal racking packages for your van, choose the one that suits your needs, adding or removing Edström accessories and components to get it right for you.



Universal



Extensible interior

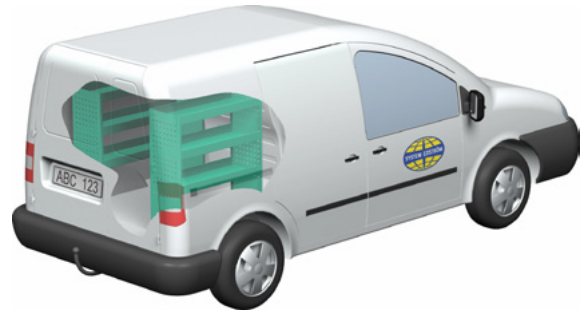

Basic Kit

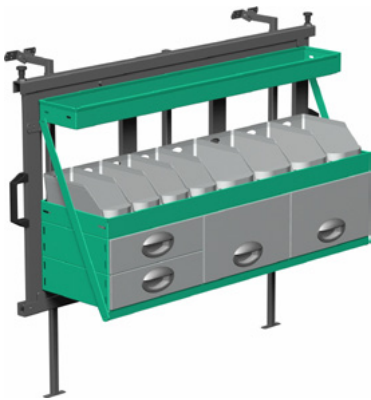

Package number F11080
W x H 1210 x 700 mm • Weight app. 50 kg



Package number F3278
W x D x H 786 x 300 x 890 mm • Weight app. 12 kg

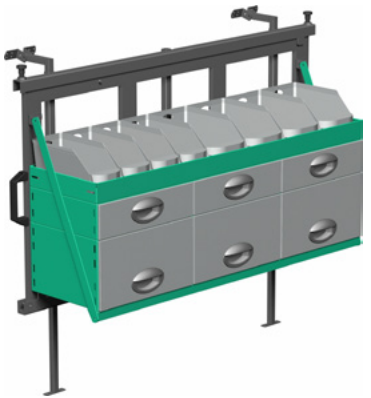

Package number F11082
W x H 1210 x 700 mm • Weight app. 55 kg



Package number F3282/F3290
W x D x H 999 x 300/200 x 890 mm • Weight app. 15/11 kg



Package number F11084
W x H 1210 x 700 mm • Weight app. 48 kg



Package number F3279
W x D x H 395 x 300 x 890 mm • Weight app. 9 kg

Universal



Sliding interior

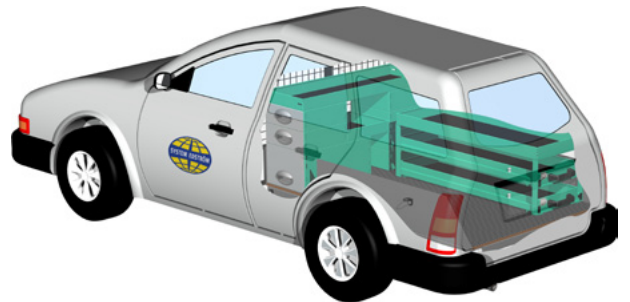

Interior/load carrier

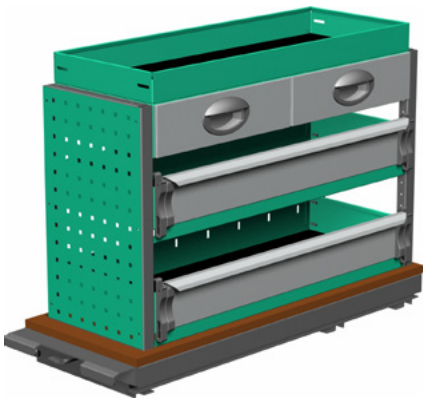

Package number F11031
W x D x H 950 x 350 x 655 mm • Weight app. 44 kg

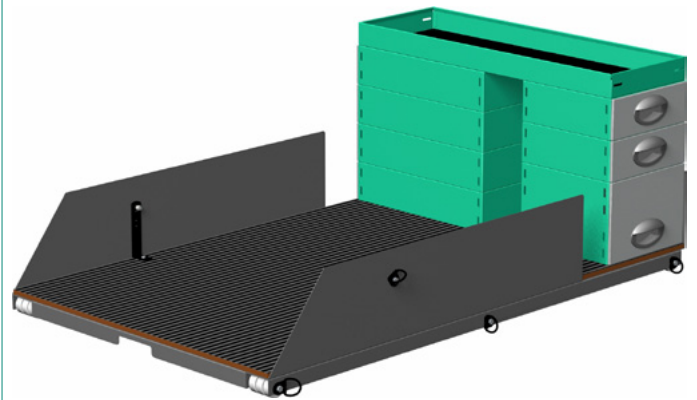

Package number F48080
W x D x H 930 x 1500 x 570 mm • Weight app. 51 kg

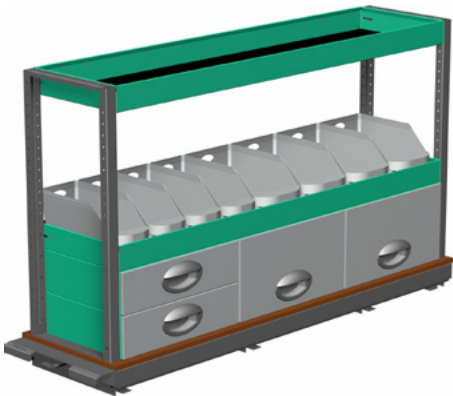

Package number F11033
W x D x H 1300 x 350 x 755 mm • Weight app. 58 kg

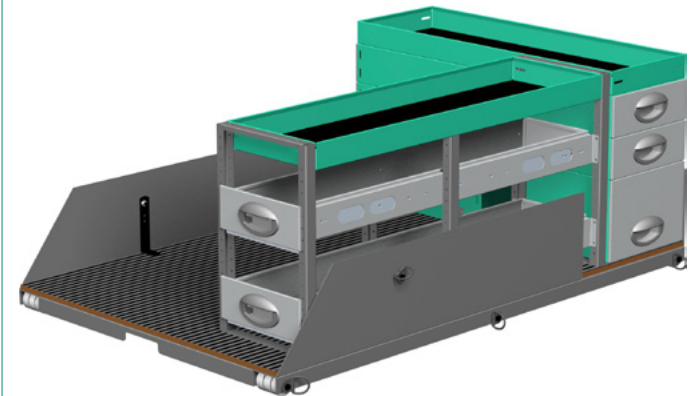

Package number F48081
W x D x H 930 x 1500 x 570 mm • Weight app. 82 kg

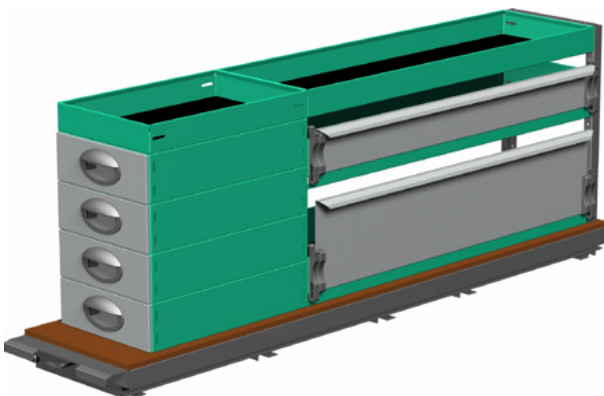



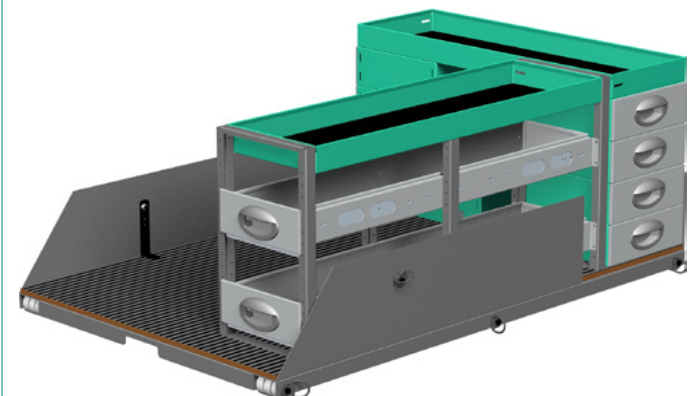







Package number F11035
W x D x H 1650 x 350 x 590 mm • Weight app. 68 kg

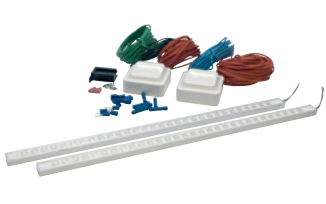

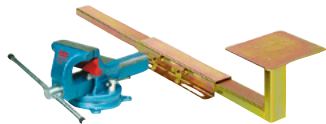
Package number F48082
W x D x H 930 x 1500 x 570 mm • Weight app. 82 kg

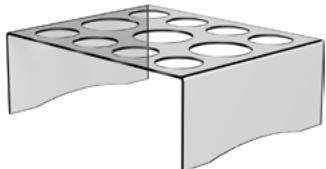
Accessories

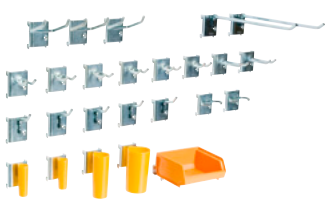

 <p>Drawer Inserts</p>	 <p>Plastic Bins</p>	 <p>Lighting</p>	 <p>Load Securing</p>
 <p>Vice</p>	 <p>Gas Bottle Holders</p>	 <p>Can/Tube Holder</p>	 <p>Case Support</p>
 <p>Tubo - Pipe Carrier</p>	 <p>Tool Holders</p>	 <p>First Aid</p>	 <p>Roof equipment</p>

Security, Environment & Quality

The company is certified according to SS-EN ISO 9001:2008 to secure the administrative quality and to give us the possibility to keep a high accuracy on deliveries.

Our products are tested in two ways, the first and most important is two crashtests, one (ECE 1707) performed by Milbrook in England and another one performed by Valutec in France (INRS NS289). German TÜV-GS has tested and approved our products regarding function and durability. Learn more about us on our homepage, www.edstrom.se.

All material used in System Edström can be recycled to 100%. We are certified according to SS-EN ISO 14001:2004.



The kits include what you see in the drawing, rubber mats to all shelves and necessary installation parts.

What you can add:

Drawer inserts, lighting kit, tool holders and more.

See us on the internet:

www.systemedstrom.com

Dealer